

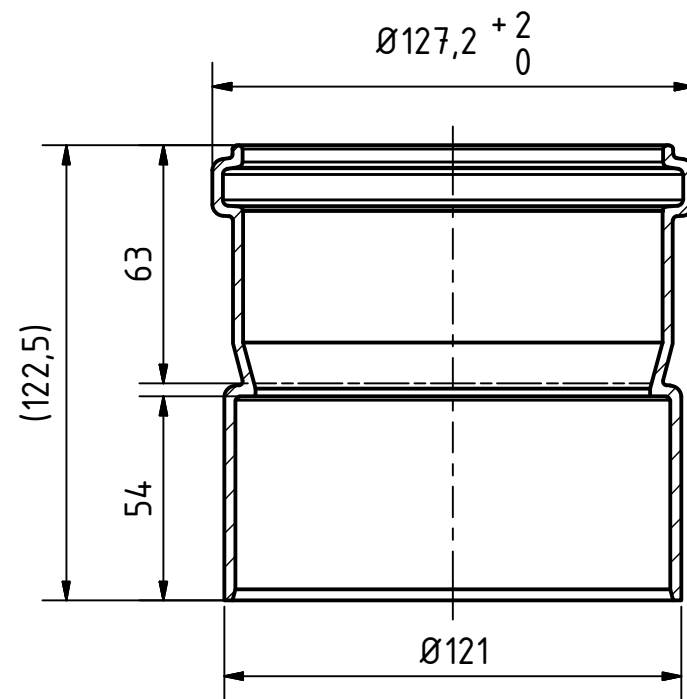

A-A (1 : 2)



		Maße nach DIN EN 1451-1		Art.Nr.: 175810		Maßstab 1:2	
				Material: PP-H schwerentflammbar			
				Datum	Name		
				Gezeichnet	01.10.2016	A.Schmedes	
				Kontroll.			
Status	Änderungen	Datum	Name	Norm			
Gebr. Ostendorf Kunststoffe GmbH Rudolf-Diesel-Str. 6-8 D-49377 Vechta verkauf@ostendorf-kunststoffe.com www.ostendorf-kunststoffe.com						<h1>HT Safe</h1>	
						<div style="border: 1px solid black; padding: 2px; display: inline-block;">1</div> A3	